



DESIGN GUIDELINES FOR 3D PRINTING

our tips
to prepare
a print ready 3D
model

Designing in 3D can at times be a very simple straight forward process, yet there are also times where even the most simple design can become extraordinarily challenging. When it comes to 3D printing, the easier you make your life, the better! Just because a 3D model looks great on the screen doesn't make it a perfect candidate for a 3D print. Some details could be lost during the 3D printing process or some elements could be too thin to print or maybe the model is not solid. Some things can be easily addressed or fixed during the design phase, or even using automatic checking and repairing tools, while other issues cannot be addressed until you actually 3D print the 3D file.

Within this guide, you will learn the tips and tricks of how to design for 3D printing and how to avoid (as much as possible) any pitfalls that could arise. Keep in mind, that even with a lot of preparation and know-how, sometimes, you cannot foresee every obstacle that 3D printing can bring. We will cover various challenges that come with preparing your 3D model for 3D printing and how to avoid mistakes that could leave your 3D file unprintable. You will also learn about design guidelines for many different materials to 3D print in, what file formats are accepted on Sculpteo and how the tools that Sculpteo provides can help repair your 3D file. As a bonus, we will share tips on how to design for personal FDM 3D Printers.

TABLE OF CONTENTS

Model Optimization	4
Ensuring File Printability	5
Optimizing Files for a 3D Print	7
Guide By Sculpteo Material	12
Plastic	13
Silver & Brass	15
Resin	17
Alumide	19
Ceramic	21
Multicolor	23
File Formats for a Sculpteo Upload	25
Sculpteo's Repair Tools	28
How Sculpteo Repair Tools Work	29
File Upload Cheat Sheets	32

Model Optimization

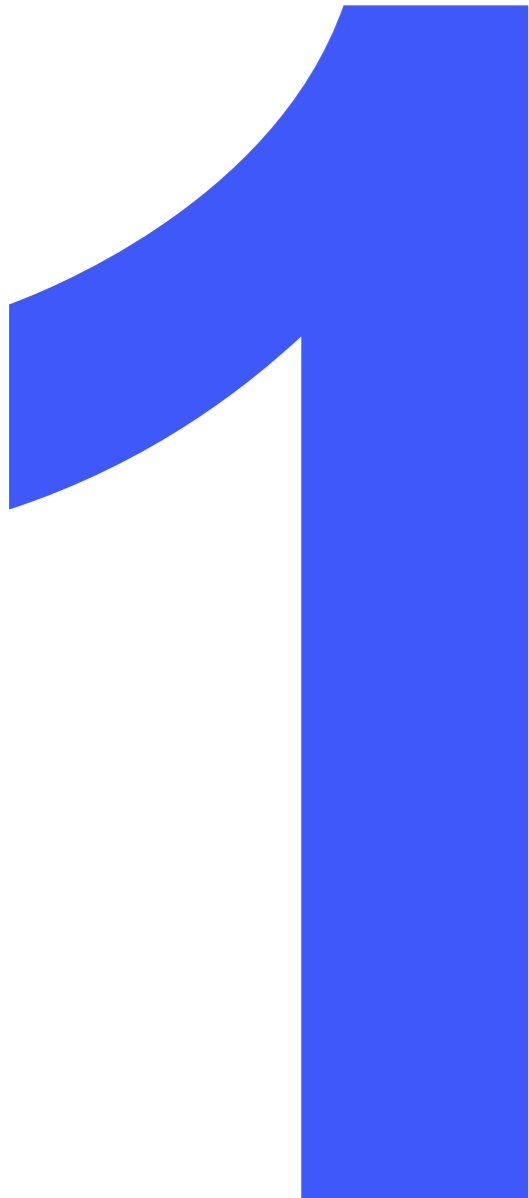

**Fundamentals for taking
files from screen to being.**

Ensuring File Printability

Pre-Upload Checks

1. Is the file watertight?
2. Is the file voluminous?
3. Is the file at your desired scale?
4. Will the file be stable in a physical form?
5. Is the file under the maximum upload file's size?

Before exporting your file from your design program there are some important questions to ask about the file (listed on the previous page). If you answer no to any of those questions, you'll have to go back and fix it for a flawless upload. Keep in mind that you can still upload unoptimized files - though the file will likely be altered by our repair tools upon upload.

Here's a rundown of everything you need to keep in mind to make sure you answer yes to each of the questions.

Watertight

The most common issue for 3D printing is whether or not your model is watertight. This means that your model has to be closed. All edges need to be connected to one another. There can be no edges or vertices that do not create a closed surface because it will have no thickness for 3D printing. You can however overlap geometry as long as all the surfaces are closed.

Voluminous



Another common mistake which can arise when exporting files (particularly files exported from a game) is that they will not be voluminous. Gaming models, for example, are optimized for a render, not a print, even if this means “cheating” a little with geometry. Hair, for instance, is sometimes modeled in simple textured faces with no volume. Such elements cannot be printed. Try to imagine a flat surface as an object: if it exists in real life, it necessarily has at least some thickness. To prepare a model for 3D printing, you must first give volume to your surfaces, for example by extruding them.

Scale

When your 3D model is created, sometimes it is created with no intention of 3D printing. This is common for things such as characters or sculptural 3D models. Most 3D software has the ability to give dimensions to your 3D model or with CAD 3D modeling, your 3D model would already contain measurements.

If you are left without the ability to resize your 3D model for any reason, when you upload to Sculpteo; you can change the scale of your model in millimeters, centimeters, meters, feet, yards, and inches.

Stability

Will the object be stable? If your model is a running character, it may have one foot in the air and the other on the ground. Are you sure it will stand? It might be a good idea to add a base.

Large objects with thin bases are best avoided, unless supported by other elements.

If you choose to produce an object such as this one:

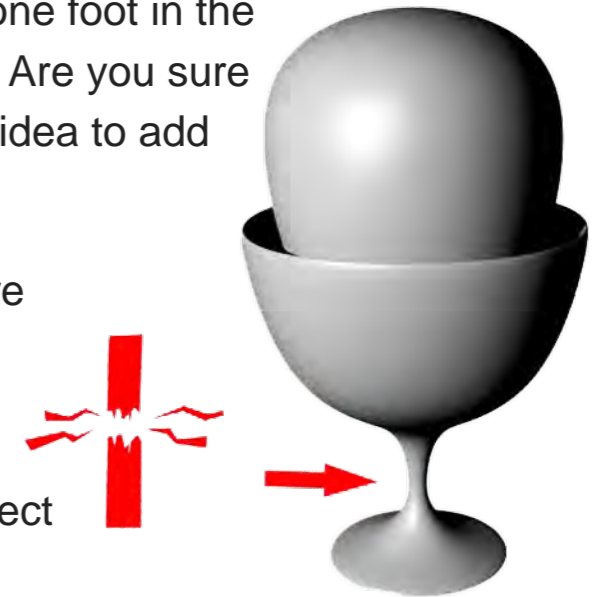

File Size

It's best not to overdo model smoothing beyond what's necessary to render. Files above the maximum size of 50 megabytes are problematic when utilizing our optimization tools post-upload.

One way to reduce the file size is to cut down on the number of faces with a decimator. Most 3D applications feature one.

If you can't find one, you can always [download Blender](#) and use the “Decimate Modifier” on your model (Edit Menu: F9).

Optimizing Files for a 3D Print

Advanced File Modifications

1. Hollowing
2. Surface Orientation
3. Interlocking Parts, Hinges & Clearances
4. Auto Intersections
5. Non-Manifold Edges & Singular Points
6. Geometric Inconsistencies
7. Structural Troubleshooting

For more experienced 3D designers there are some tricks that can help not only ensure the printability of your models, but also optimize the price. This section can help if you already have a background when it comes to 3D printing.

1. Hollowing

If your model is large or you want to decrease the amount of material used for weight or cost savings, then hollowing your model is the way to go. If you want some parts of your object to be hollow, remember to create a hole in the model so that the excess plastic powder can be removed after the print. You can do this in your 3D software or you can use the online hollowing feature after uploading your 3D file to Sculpteo.

2. Surface Orientation

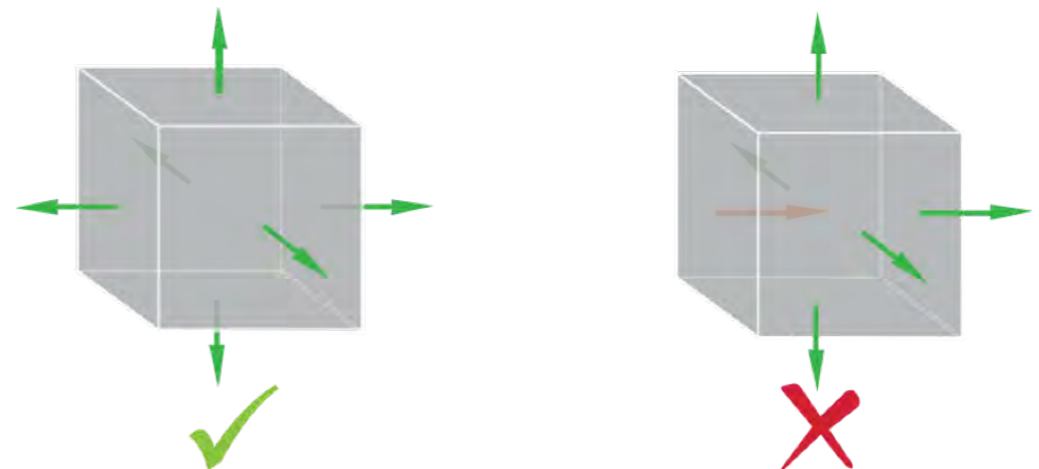

In most 3D modeling softwares, surfaces are oriented with an inside and an outside to help determine the model's volume. If one of the faces of an object is oriented in the wrong direction, it's volume may be indeterminate by our online software. It is important to reassure that each face is oriented in the correct direction in order to avoid that type of problem.

3. Interlocking Parts, Hinges & Clearances

If you are 3D printing a 3D model that has multiple parts or pieces that will be assembled, depending on the 3D printing process, you will need to be sure that there is enough space to join the pieces together. If you plan to have your 3D model 3D printed in one piece without having to assemble afterwards, then you need to make sure that there is enough clearance between any moving parts such as ball joints, hinges, gears, cogs or chain links. If minimum clearances are not met, your 3D model could possibly fuse together during the 3D printing process and making your 3D printed model solid instead of movable.

Also consider that some materials allow you to create complex assemblies of objects that 3D printing alone could not accomplish. We recommend consulting our design guidelines in the next section before beginning your design project.

From a general statement we recommend using our white plastic to produce moving parts. With this material, a 0.5 mm clear-

ance is recommended to ensure the joint can move freely. Keep in mind that the minimum clearance is depending on the shape of the object and the depowdering process. A clearance of 1 mm might be needed if the joint is difficult to depowder.

4. Auto Intersections

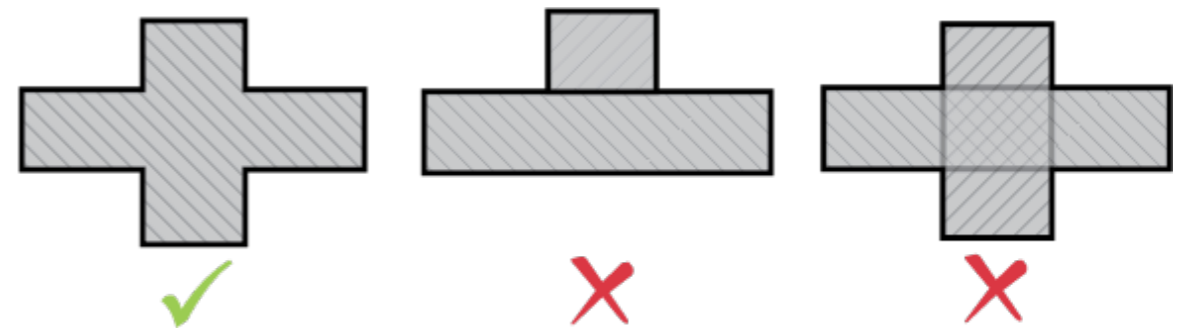

As you create your 3D model, there may be a point when two or more volumes cut into each other. These intersections create an ambiguous model with uninterpretable volumes. 3D Modeling softwares often have a function that can merge these elements, rendering a singular object - for specifics in a particular program, see our tutorials on modeling a 3D printable file.

5. Non-Manifold Edges & Singular Points

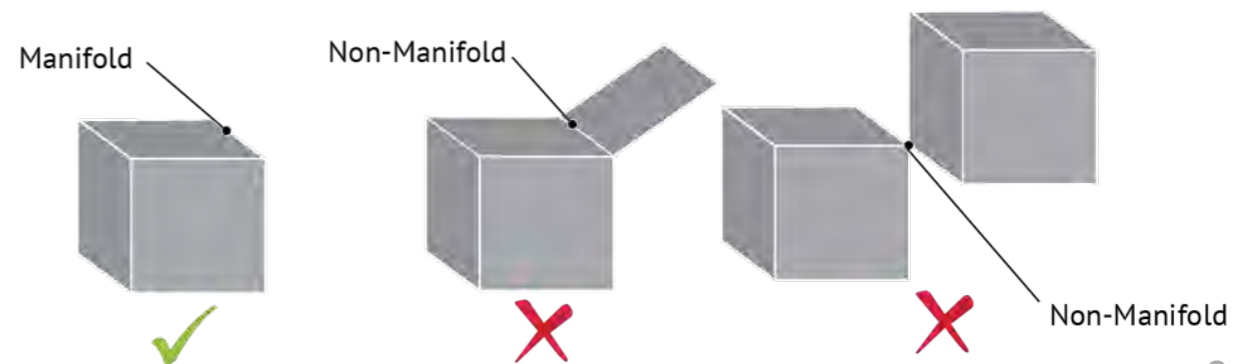

During the conception of your 3D file, certain operations may create unattached, ambiguous surfaces which do not connect. Other operations may separate surfaces, creating singular point of connection. These singularities prevent our online tools from determining the volume of the model.

To define a clear volume, each side must be connecting two and only two adjacent faces. Similarly, singular points must arrive at the collection of multiple faces. If two faces share only one point (as shown in the image below), the model is considered "non-manifold" and will not be able to be printed.

These singularities can be eliminated by either disconnecting the non-manifold surface and giving it volume, or by deleting it completely.

6. Geometric Inconsistencies

Geometric inconsistencies may prevent our printers from understanding your 3D file. The most common problem we run in to is that your file does not consist of a single, solid, and uniform object. Our printer is then unable to determine the interior and exterior of the model and will render the file 'Not Orientable'.

The majority 3D modeling programs available today are not created specifically for 3D printing; they often include animation and visual rendering tools. Animation and visual renderings do not require solid/closed objects in order to render (the priority is

instead placed on the model's surface), however a file destined for a 3D print requires more than a simple surface - a 3D print requires volume.

7. Structural Troubleshooting

A 3D model that looks great on the computer screen will sometimes not translate very well to the real world. So, you must adhere to the minimum requirements for the specific 3D printing process you choose to utilize. 3D models that have really thin features could break, especially if that thin area were to support a large or heavier 3D printed surface. So every 3D model that will be 3D printed must have a minimum shell or wall thickness to 3D print.

Minimum shell or wall thickness is dependent on which material you decide to 3D print with. However, if you go too thin, your 3D print will be fragile and you could create holes in your geometry without knowing it. By abiding by the minimum wall thickness, you can avoid unnecessary breakage and avoid printer errors when trying to 3D print.

Smaller details such as animal whiskers, wires or cables can be very fragile, or even impossible to print, if they are not thick enough.

The little character to the right has long, fine whiskers. If this object were created in our multi-color, you could expect them to break, given their thin and extruding nature.

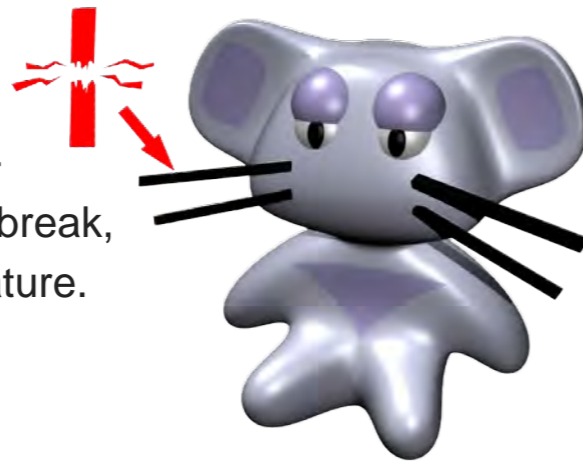

There are several ways of dealing with fragile details:

- By increasing their thickness. This can work for cartoon-like figures, where exaggeration of detail is not a problem.
- By sticking the detail to a solid part of the model, as if it was resting on the model. For instance, a cat's whiskers stuck to its cheek.
- By removing them altogether. You can design spaces on the model to place a wire, string or small chain, and add them after printing. It's very easy to stick all sorts of details onto the printed material with regular glue.

Here, we have changed the design of our character's whiskers in a way that will make them more sturdy once printed.

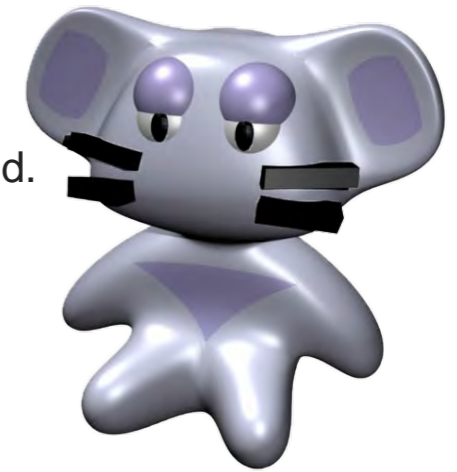

In any case, a minimum thickness of 3-4 mm is recommended for details that “stick out” of a colour object, and 2 mm for the white material. For reliefs, 1 mm accuracy is enough as the details are stuck to the model background and therefore much more solid.

Full Color Printing

For full color 3D printing, you need to have a 3D model that also has either vertex color or a texture image file attached. When you prepare your files for full color 3D printing, you need to .zip your files together so the service provider will know which files should be combined. While image files can be accepted like .jpg or .png for instance; depth maps such as displacement, bump or normal maps will not 3D print correctly. These files are associated with 3D rendering for computer graphics and are not suitable for 3D printing.

Warning: .obj files require a .mlt file (generated when exporting to obj with your modelling software) in addition to the textures. This file contains colour-indexing and texture data. Because of its lack of limitations and relative compatibility with most 3D tools, the .obj format is recommended for coloured objects in general, although other formats are supported by Sculpteo.

Colour rendering of an object produced by 3D software is often very different from reality, because software makes use of artificial lighting that can dull, lighten or transform the object's actual colours. To get an idea of the finished object's actual colours, you should check out the rendering on Sculpteo's online 3D viewer, which most faithfully reflects the object's appearance.

Note that it's impossible to print transparent parts of the object in clear material when you choose multicolor material. If you design a protective glass screen on a mobile handset, it will appear opaque, and will conceal the texture of the menu placed below it.

You should therefore remove any transparent part if you want to see what's behind it. One option is to change the object's texture to simulate a transparent effect.

Say we put a fishbowl over our little guy's head:



The printer will produce something like this:



Guide By Sculpteo

Material



Each material has its own set of rules and parameters to ensure a quality print. What'll it be: Plastic? Resin? Multicolor? Ceramic? Bronze? Silver? (I think you get the idea.)

Plastic

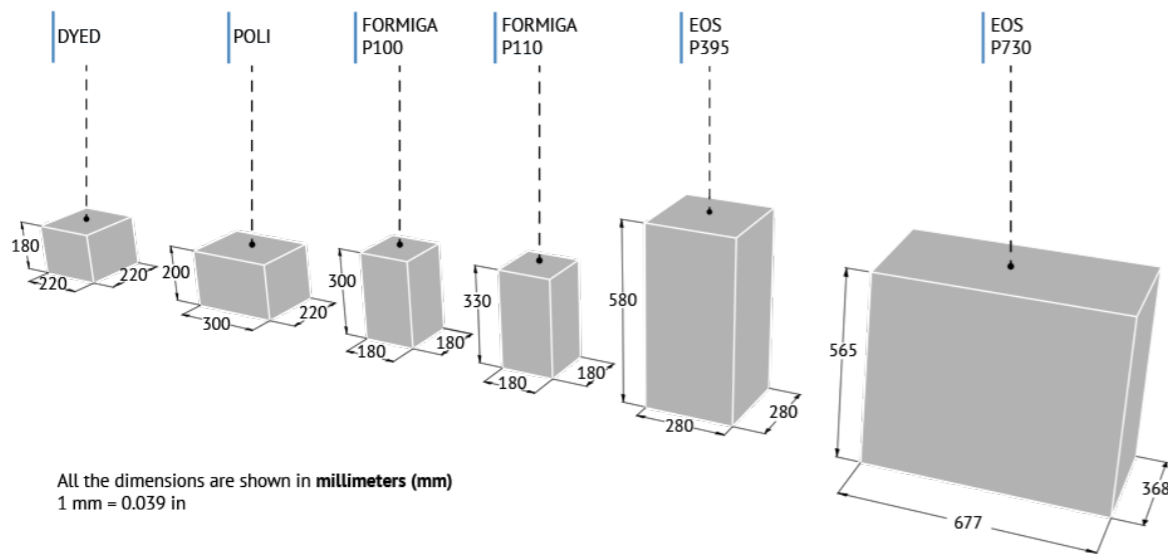

Design Guides

Minimum thickness	0.8mm
Minimum details	0.3mm
Minimum clearance	0.5mm
Interlocking parts?	Yes
Standard Layer Thickness	100-150µm
High Definition Layer Thickness	60µm
Accuracy	± 0.3% (limit of ± 0.3 mm)

At a Glance

Strength:

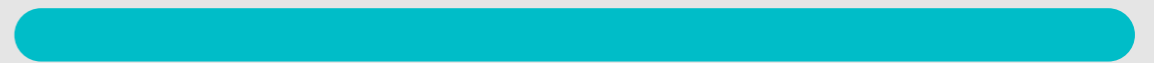

Details:

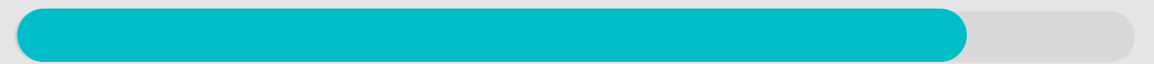

Surface Look:



Flexibility



Enclosures & Interlocking Volumes



Possible to inclose or interlock volumes? Yes

Etching & Embossing

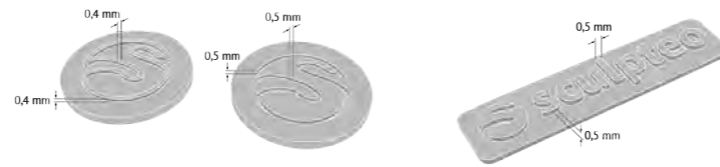

Min detail size: 0.3mm • Min height/width: 0.4mm • Min depth/width: 0.5mm

Piece Assembly Restrictions



Possible piece assembly? Yes • Min spacing: 0.5mm

Min Spacing & Clearances



Possible piece assembly? Yes • Min spacing: 0.5mm

Hollowing

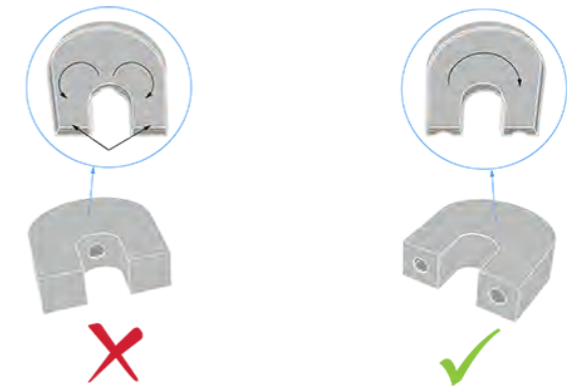

Possible to hollow the object? Yes

[For more information visit Sculpteo's Plastic Material Page](#)

Silver & Brass

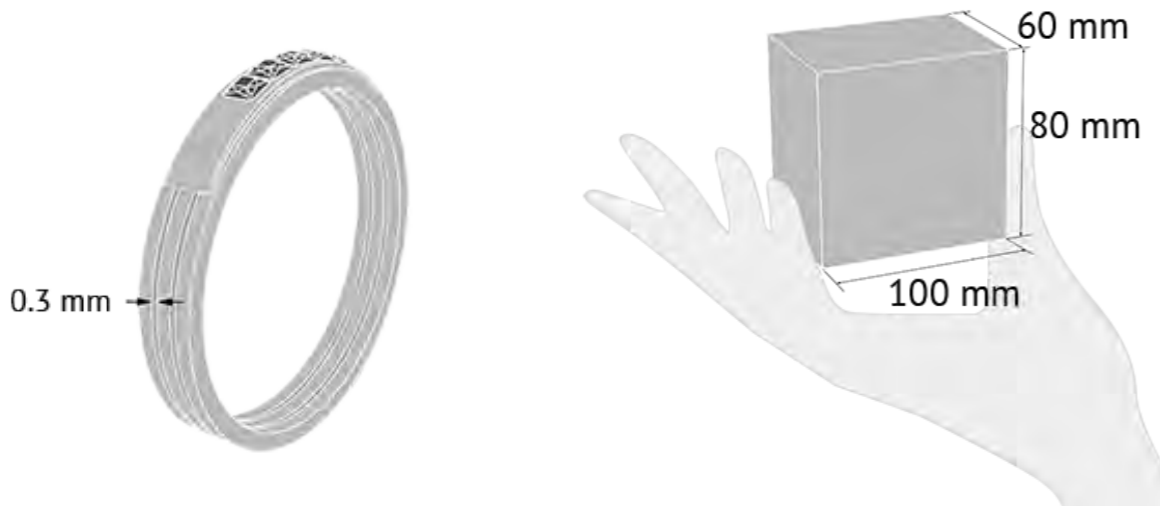

Design Guides

Standard layer thickness	25µm
Max Size (mm)	60x 80x 100
Min Size (mm)	2.4x 2.4x .8
Min spacing between walls	0.3 mm

At a Glance

Strength:

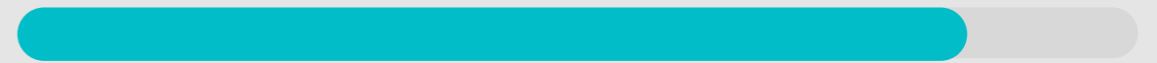

Details:

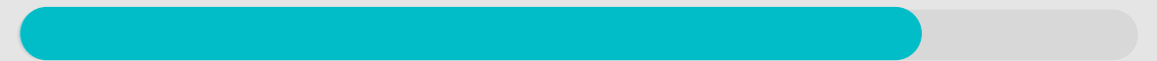

Surface Look:

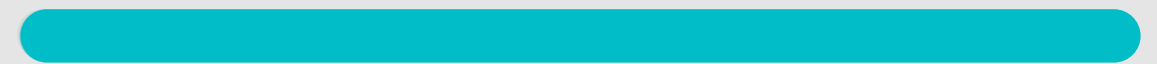

Flexibility



Enclosures & Interlocking Volumes



Possible to include enclosed or interlocking volumes in design? No

Etching & Embossing

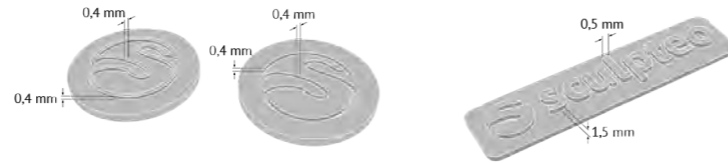

Min detail size: 0.3mm • Min height/width: 0.4mm • Min depth/width: 0.5mm •
Legible text: 0.5mm

Piece Assembly Restrictions



Possible piece assembly? No

Min Spacing & Clearances

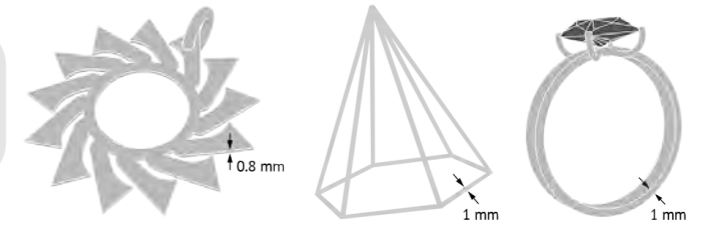

Minimum spacing required between parts: 0.8 mm

Hollowing



Possible to hollow? No

[For Additional Information visit Sculpteo's Silver Material Pages](#)

Resin

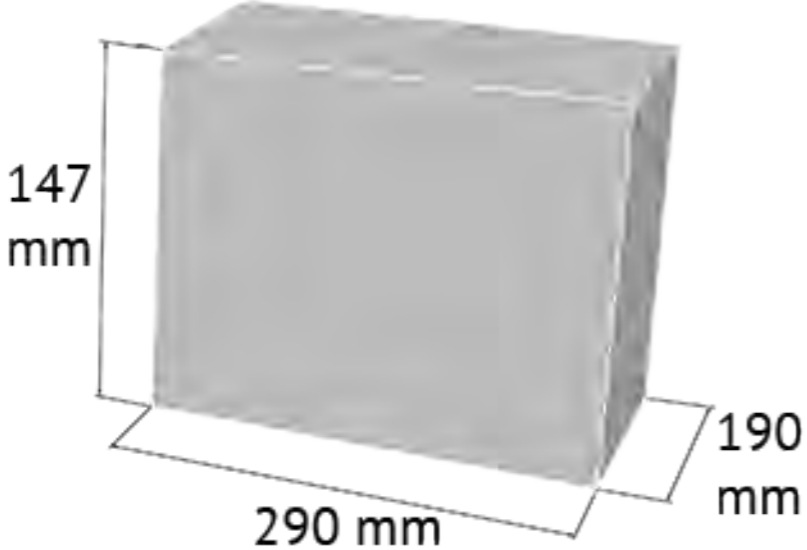

Design Guides

Standard layer thickness	28 μ m
Max Size (mm)	290 x 190 x 147
Min wall thickness	2 mm
Min spacing between walls	0.3 mm

At a Glance

Strength:



Details:

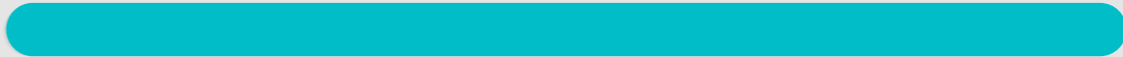

Surface Look:

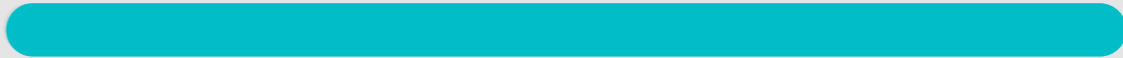

Flexibility



Enclosures & Interlocking Volumes



Possible to include enclosed or interlocking volumes in design? Yes

Etching & Embossing

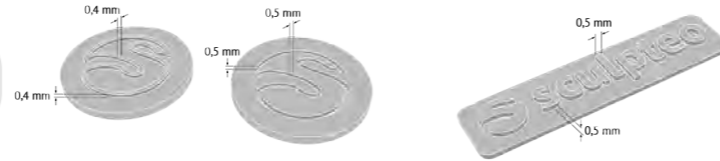

Min detail size: 0.3mm • Min height/width: 0.4mm • Min depth/width: 0.5mm • Legible text: 0.5mm

Piece Assembly Restrictions



Possible piece assembly? Yes • Min spacing: 0.4mm

Min Spacing & Clearances



Minimum spacing required between parts: 0.4mm

Hollowing



Possible to hollow? No

[For Additional Information visit Sculpteo's Brass Material Pages](#)

Alumide

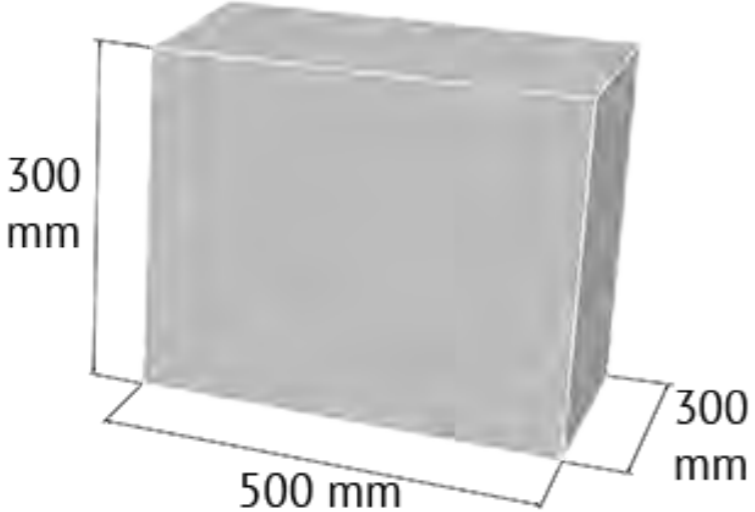

Design Guides

Minimum thickness	1mm
Minimum details	1mm
Minimum clearance	0.5mm
Interlocking parts ?	Yes

At a Glance

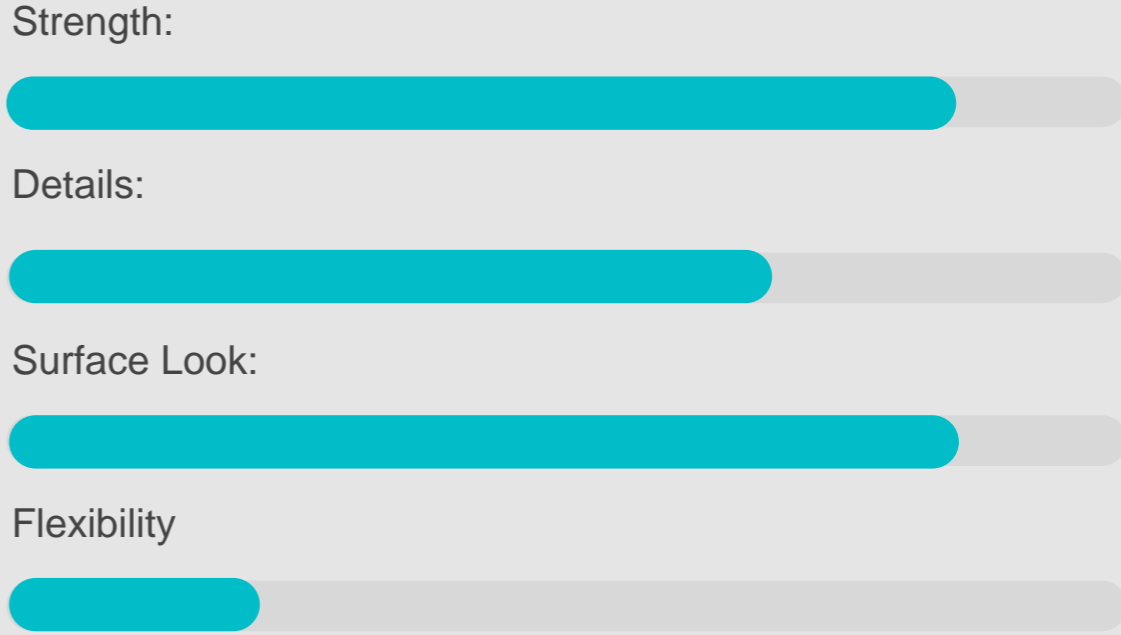

Enclosures & Interlocking Volumes



Possible to include interlocking/enclosed parts in design? Yes

Etching & Embossing

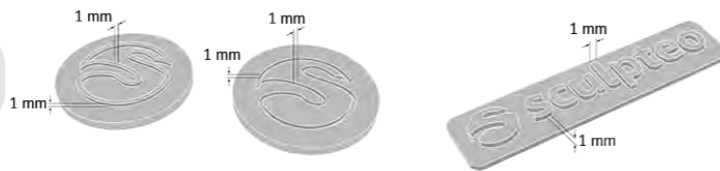

Min detail size: 1mm • Min height/width: 1mm • Min depth/width: 1mm • Legible text: 1mm

Piece Assembly Restrictions



Possible piece assembly? Yes • Min spacing: 0.5mm

Min Spacing & Clearances

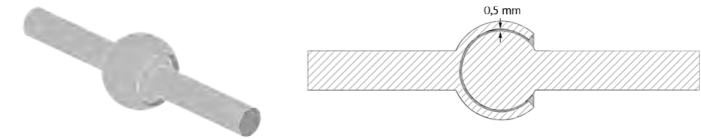

Minimum spacing required between parts: 0.5mm

Hollowing

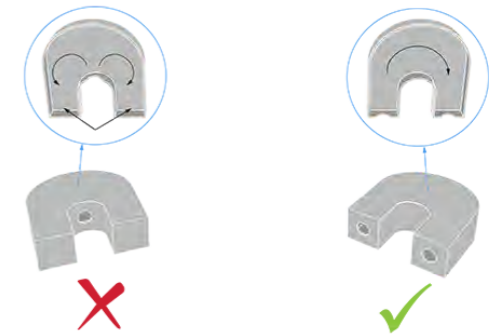

Possible to hollow? Yes

[For Additional Information visit Sculpteo's Alumide Material Page](#)

Ceramic

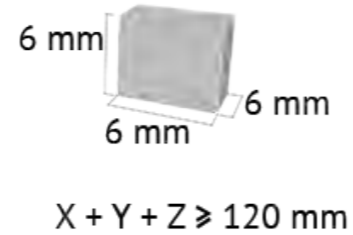
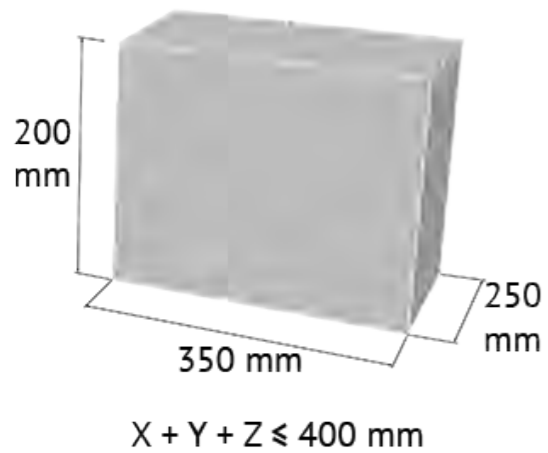

Design Guides

Minimum thickness	3-6mm
Maximum thickness	15mm
Minimum details	2-3mm
Minimum clearance	N/A
Interlocking parts	No

At a Glance

Strength:

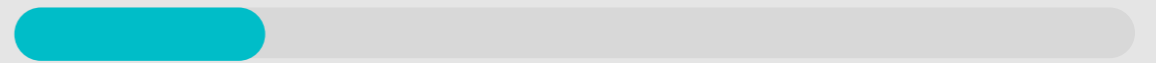

Details:



Surface Look:

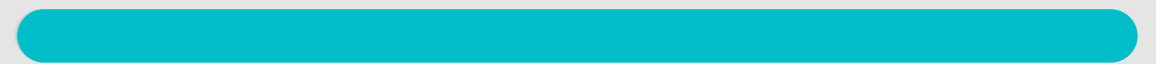

Flexibility

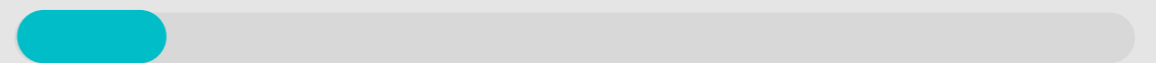

Etching & Embossing

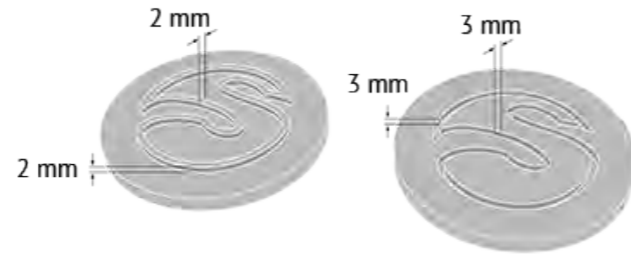

Min detail size: 2mm • Min height/width: 2mm • Min depth/width: 2mm

Enclosures & Interlocking Volumes



Possible to include interlocking/enclosed parts in design? No

Piece Assembly Restrictions



Possible piece assembly? Yes • Min spacing: 0.4mm

Hollowing

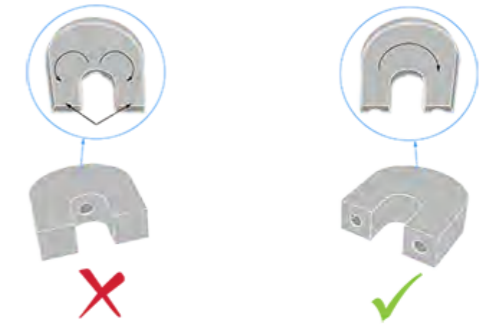

Possible to hollow? Yes

Multicolor

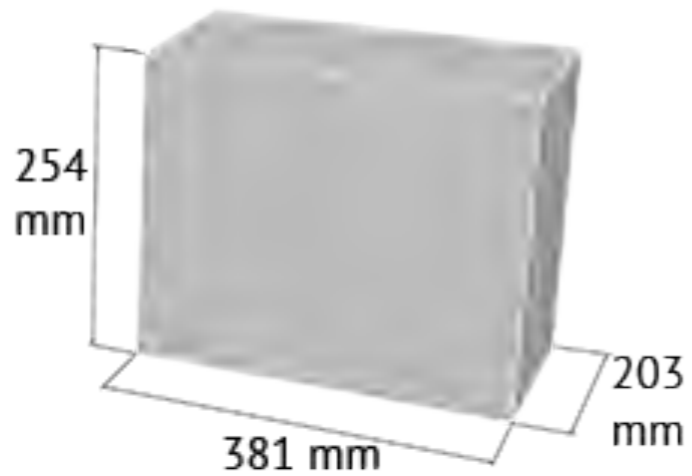

Design Guides

Minimum thickness	2mm
Minimum details	0.4mm
Minimum clearance	N/A
Interlocking parts	No

At a Glance

Strength:

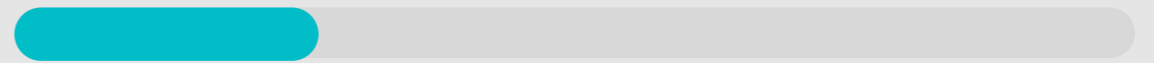

Details:

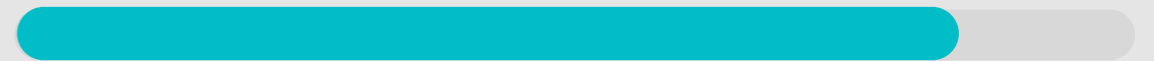

Surface Look:



Flexibility

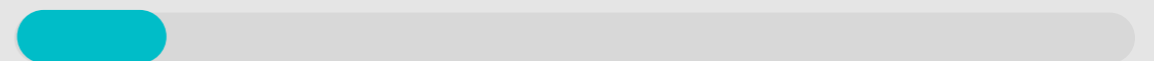

Enclosures & Interlocking Volumes



Possible to include interlocking/enclosed parts in design? No

Etching & Embossing

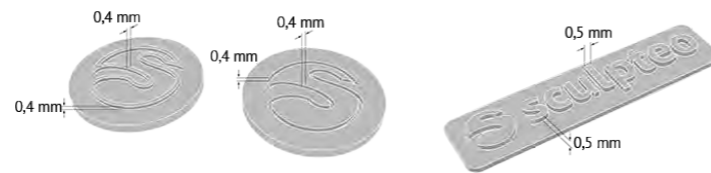

Min detail size: 0.4mm • Min height/width: 0.4mm • Min depth/width: 0.4mm •
Legible text: 0.5mm

Piece Assembly Restrictions



Possible piece assembly? Yes • Min spacing: 0.4mm

Min Wall Thicknesses

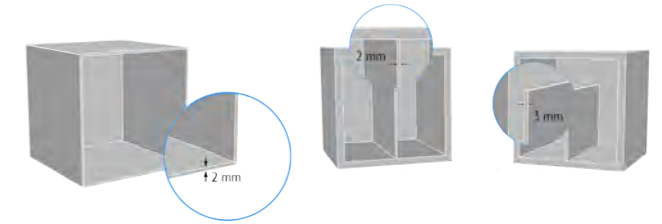

Minimum wall thickness: 2 mm • Minimum wall thickness for particular design aspect: 3 mm

Hollowing

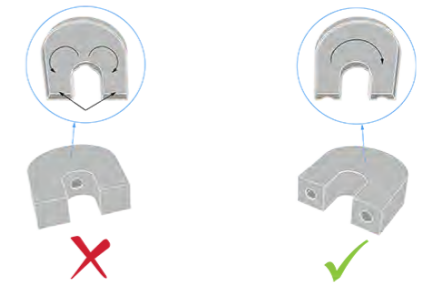

Possible to hollow? Yes

[For Additional Information visit Sculpteo's Multicolor Material Page](#)

File Formats for a Sculpteo Upload



Ok, so the model is perfect and ready for an export, but what type of file should you export it as?

***Hint: We accept over 25 types.**

Format	3D Geometry	Colors	Textures	Additional Information
STL	✓	✗	✗	
OBJ (Wavefront)	✓	✓	✓	Colors feature is supported if the MTL, OBJ and image files for the textures are archived in a ZIP file. Textures feature is supported if the image files for the textures and the 3D model is archived in a ZIP file.
SKP (Sketchup)	✓	✓	✓	
OFF	✓	✗	✗	
PLY (Standford)	✓	✓	✗	
KMZ (Google Earth)	✓	✓	✓	
3DS (3D Studio)	✓	✓	✓	Textures feature is supported if the image files for the textures and the 3D model is archived in a ZIP file.
AC3D	✓	✓	✓	Textures feature is supported if the image files for the textures and the 3D model is archived in a ZIP file.
DAE (Collada)	✓	✓	✓	Textures feature is supported if the image files for the textures and the 3D model is archived in a ZIP file.
MD2/MD3 (Quake)	✓	✗	✗	
Q3O (Quick3D)	✓	✓	✓	
COB (TrueSpace)	✓	✓	✗	

Format	3D Geometry	Colors	Textures	Additional Information
DXF (AutoCAD)	✓	✓	✗	Up to Release 12 version of the format.
LWO (LightWave)	✓	✓	✓	Textures feature is supported if the image files for the textures and the 3D model is archived in a ZIP file.
IGES	✓	✗	✗	
STEP (ISO 10303)	✓	✗	✗	
VRML	✓	✓	✓	Textures feature is supported if the image files for the textures and the 3D model is archived in a ZIP file.
SCAD (OpenSCAD)	✓	✗	✗	
ZIP	✓	✓	✓	An archive containing any supported 3D file, textures and colors.
RAR	✓	✓	✓	An archive containing any supported 3D file, textures and colors.
TGZ	✓	✓	✓	An archive containing any supported 3D file, textures and colors.

Sculpteo's Repair Tools

Sculpteo has a team of highly skilled, automatic and free tools for you to use whenever you upload. Here's a rundown of them.

4

How Sculpteo Repair Tools Work

When a non-printable file is uploaded to our site, it is automatically analyzed and corrected by our repair algorithms. There are few problems which our algorithms are not able to repair. However when a file is repaired, we also offer different algorithmic reparations, giving you a choice of how your file will be repaired.

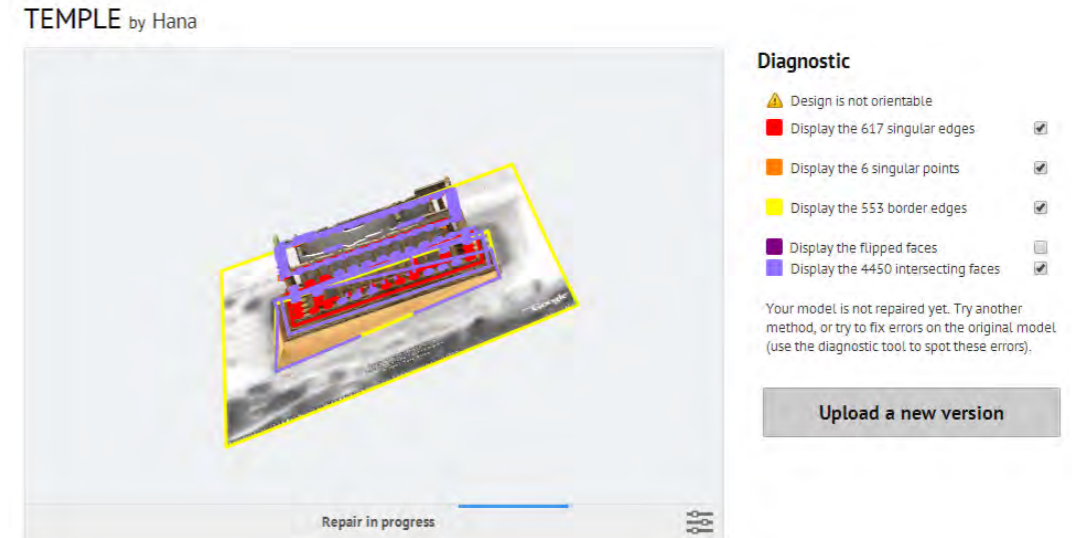
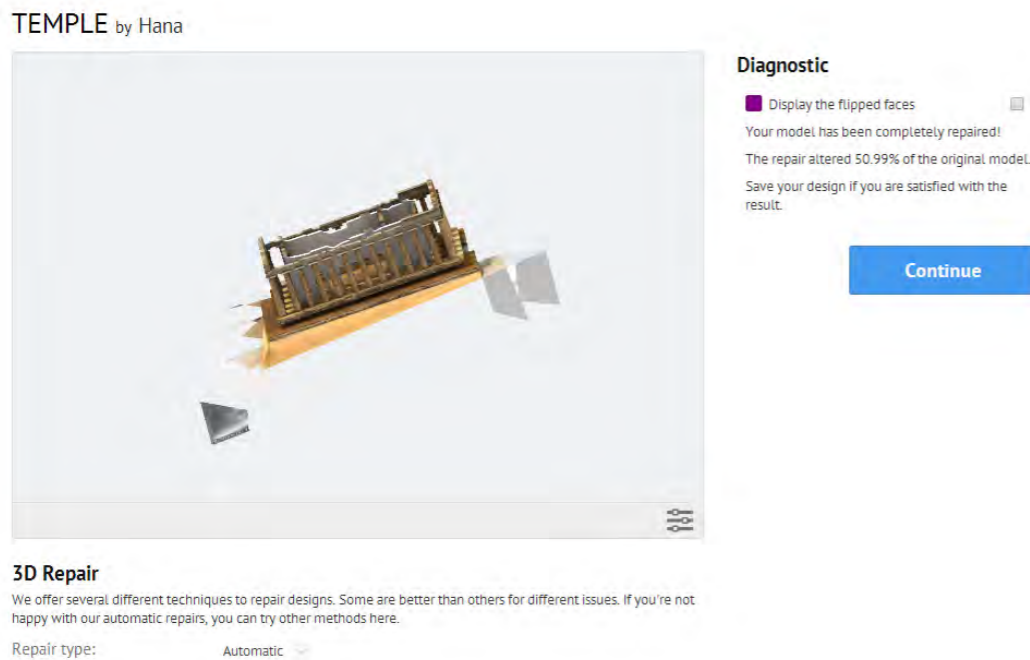

Diagnose Your 3D File

You are able to access the 3D file diagnostics in the top right portion of your screen. The diagnostic will point out the errors in your 3D file and will show you exactly where those problems arise in the 3D viewer. The file then updates according to the repair options you choose. Choosing "None" in the drop-down menu will show your original file and you will be able to visualize each of the errors detected by our software.

The diagnostic check will show the following errors. To know more, you can check our paragraph explaining how to correct 3D file manually for 3D printing.

- Edge Stops (surfaces that do not contribute to the border of a volume)
- Singular sides and points (non-manifold)
- Intersecting Faces (auto-intersections)
- Inverted Faces (orientation)

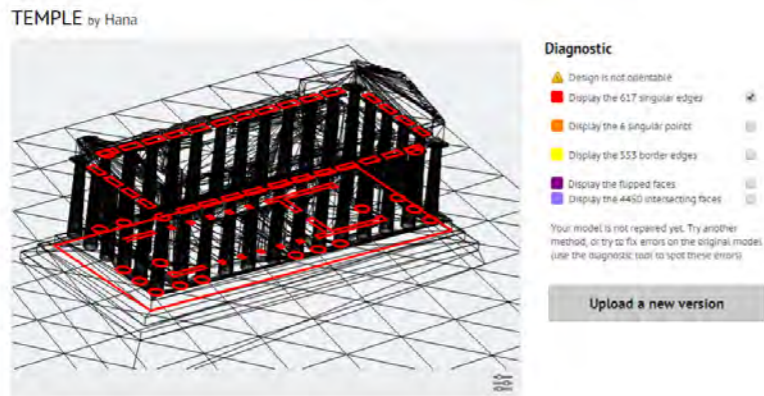

3D Repair
We offer several different techniques to repair designs. Some are better than others for different issues. If you're not happy with our automatic repairs, you can try other methods here.
Repair type: None

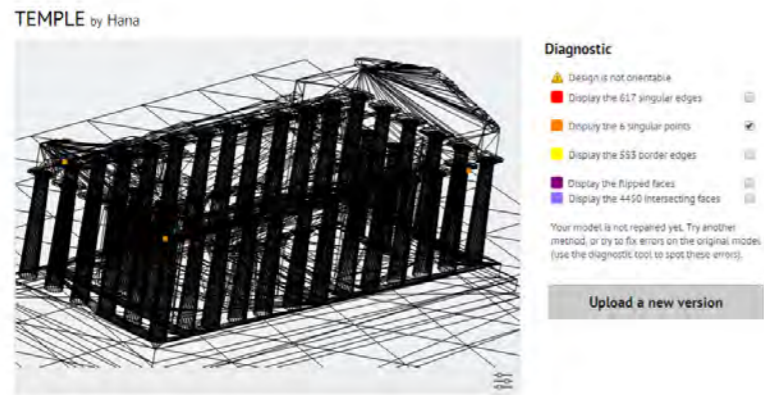

3D Repair
We offer several different techniques to repair designs. Some are better than others for different issues. If you're not happy with our automatic repairs, you can try other methods here.
Repair type: None

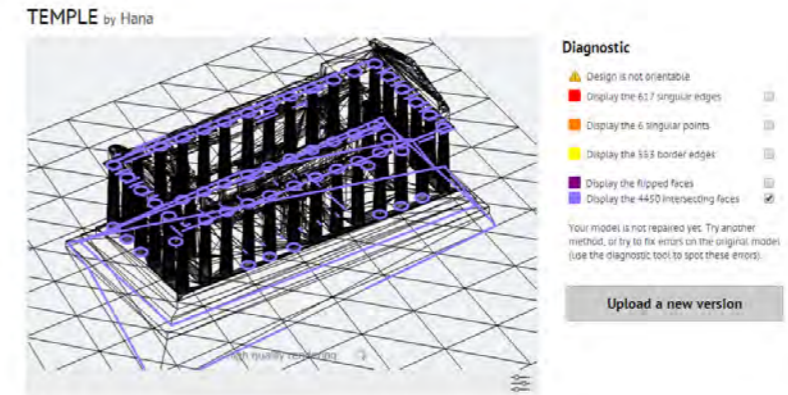

3D Repair
We offer several different techniques to repair designs. Some are better than others for different issues. If you're not happy with our automatic repairs, you can try other methods here.
Repair type: None

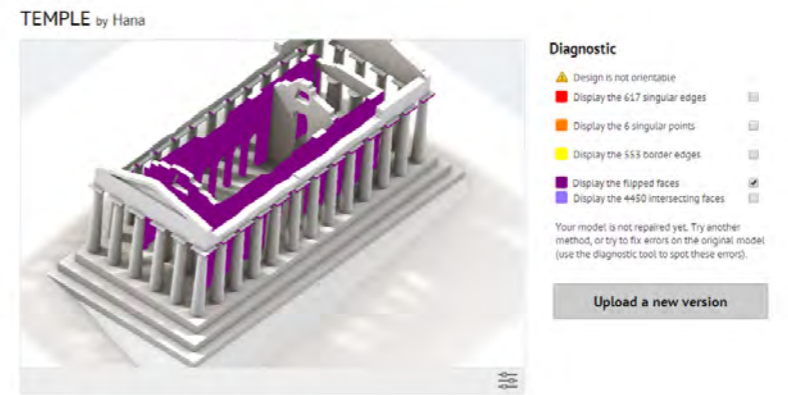

3D Repair
We offer several different techniques to repair designs. Some are better than others for different issues. If you're not happy with our automatic repairs, you can try other methods here.
Repair type: None

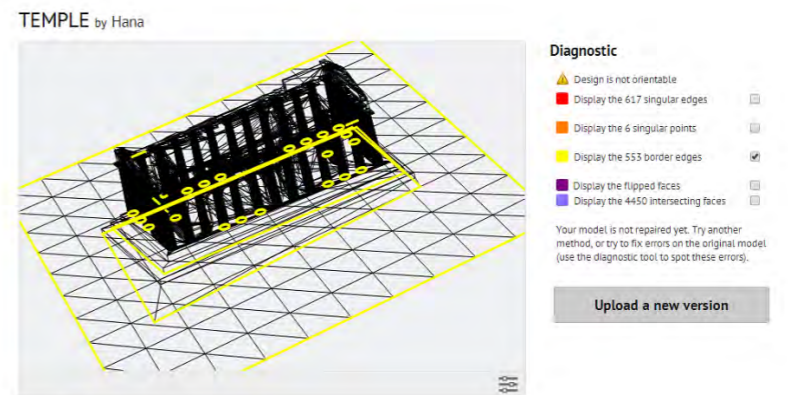

3D Repair
We offer several different techniques to repair designs. Some are better than others for different issues. If you're not happy with our automatic repairs, you can try other methods here.
Repair type: None

Repair your 3D file

If our auto repair function alters your 3D file significantly or does not result in a fully corrected version, you will be redirected to our repair page. If you are not satisfied with the repairs, you can change your 3D file and upload it again or try other methods of correction directly on our website. To do this, simply select one of the remedies proposed in this drop below the 3D viewer menu and choose the one that suits you best. Once the repair is chosen, you can click "Continue".

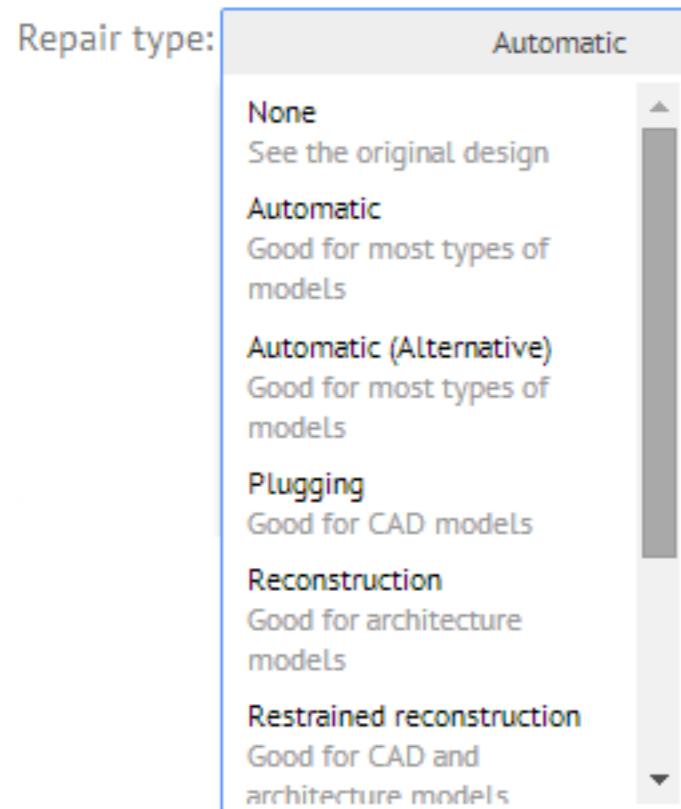

We offer the following repair functions:

- Automatic : Optimized for most file types
- Plugging : Good for CAD models
- Reconstruction : Good for architecture models
- Restrained reconstruction : Good for CAD and architecture models
 - Visible reconstruction : Good for miniatures or small non-mechanical objects"
 - Hybrid Reconstruction : Good for models made of multiple parts

The Pre-Print Cheat Sheet

5

Bonus! Keep these pages by your side when you're prepping a model for a 3D print.

***Tips for both Sculpteo *and* Personal FDM printers!**



MATERIALS

- Check the smallest details: ensure they are able to print at the size or resolution you are printing
- Ensure that interlocking parts and hinges have enough clearance
- Ensure that there is enough tolerance for any parts that will be assembled after 3D printing

OPTIMIZE

- Check to see if your model can benefit from hollowing to save our material
- Rescale your 3D model's overall size to save on material
- If you want to print multiple units, review your batch

REVIEW

- Check to make sure that you 3D model's wall are not too thin
- Ensure that your model has a Minimum Shell or Wall Thickness for the material you will 3D print your model in
- Check to see if your model is proper size in millimeters, centimeters, meters, feet, yards or inches
- Check if your models polygon count needs to be increased to retain any smooth features



- Will your model fit the build area?
- Have you accounted for material shrinkage?
- Is your model prone to warping (is it long/thin)?
- Have you created supports where necessary?
- Are design holes large enough?
- Are walls at least 1mm thick?
- Could your model benefit from chamfers or fillets for extra support?
- Is your model highly detailed (would it benefit from being sliced into multiple parts)?
- Would your model benefit from sanding or an acetone post bath?

Stay Current with Sculpteo!

